

## 1



### Battery safety warnings



- Working in the vicinity of a lead acid battery is dangerous. Batteries can generate explosive gases during operation. Never smoke or allow a spark or flame in the vicinity of a battery. Provide sufficient ventilation around the battery.
- Wear eye and clothing protection. Avoid touching eyes while working near batteries. Wash your hands when done.
- If battery acid contacts skin or clothing, wash them immediately with soap and water. If acid enters an eye, immediately flood the eye with running cold water for at least 15 minutes and get medical attention immediately.
- Be careful when using metal tools in the vicinity of batteries. Dropping a metal tool onto a battery might cause a short circuit and possibly an explosion.
- Remove personal metal items such as rings, bracelets, necklaces, and watches when working with a battery. A battery can produce a short circuit current high enough to melt objects such as rings, causing severe burns.
- Disconnect the negative pole of the battery before installation.

## 2

### Battery monitor BMV contents

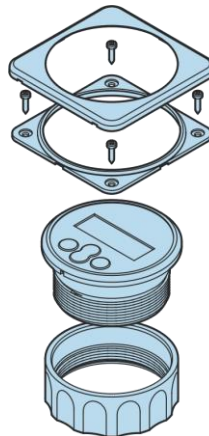
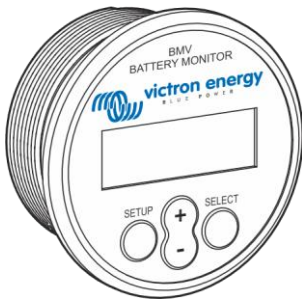

Front plate

4 screws

Attachment flange

BMV head unit

Attachment sleeve

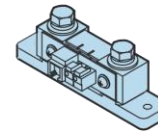

BMV shunt



RJ12 cable (10m)



Two power cables (2m)

## 3

### Full manual available online

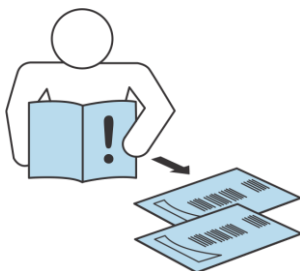

BMV712 product page



<https://ve3.nl/5x>

## 4

### BMV and mounting dimensions

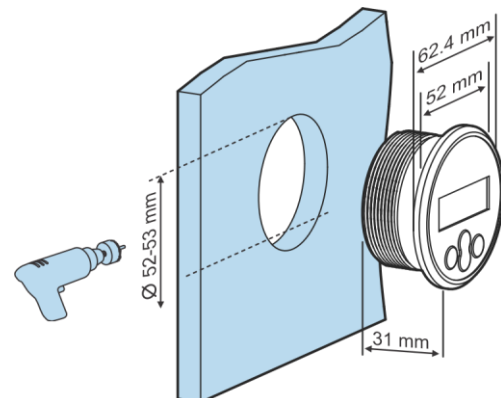

**5A**

**Mounting option A**

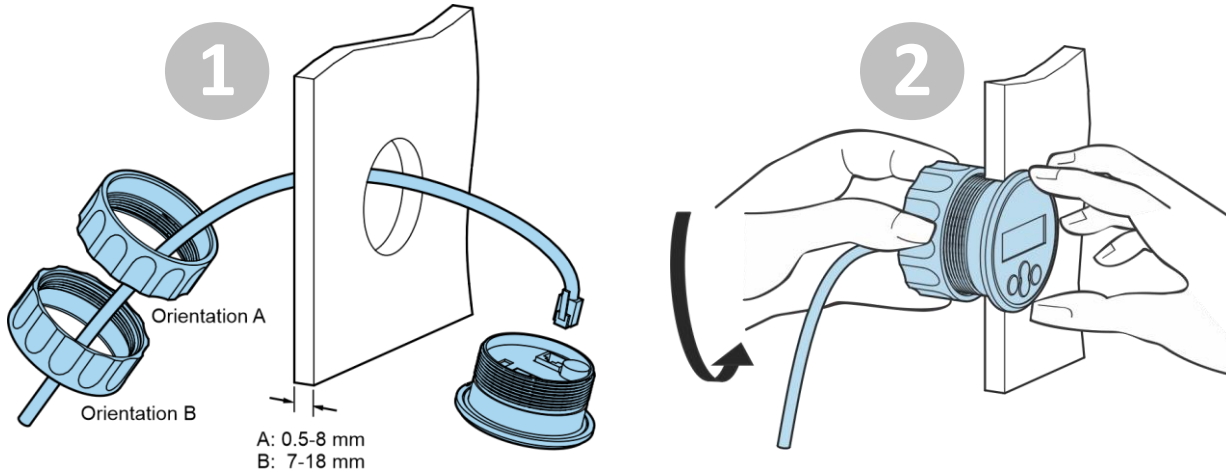

Option A

**5B**

**Mounting option B**

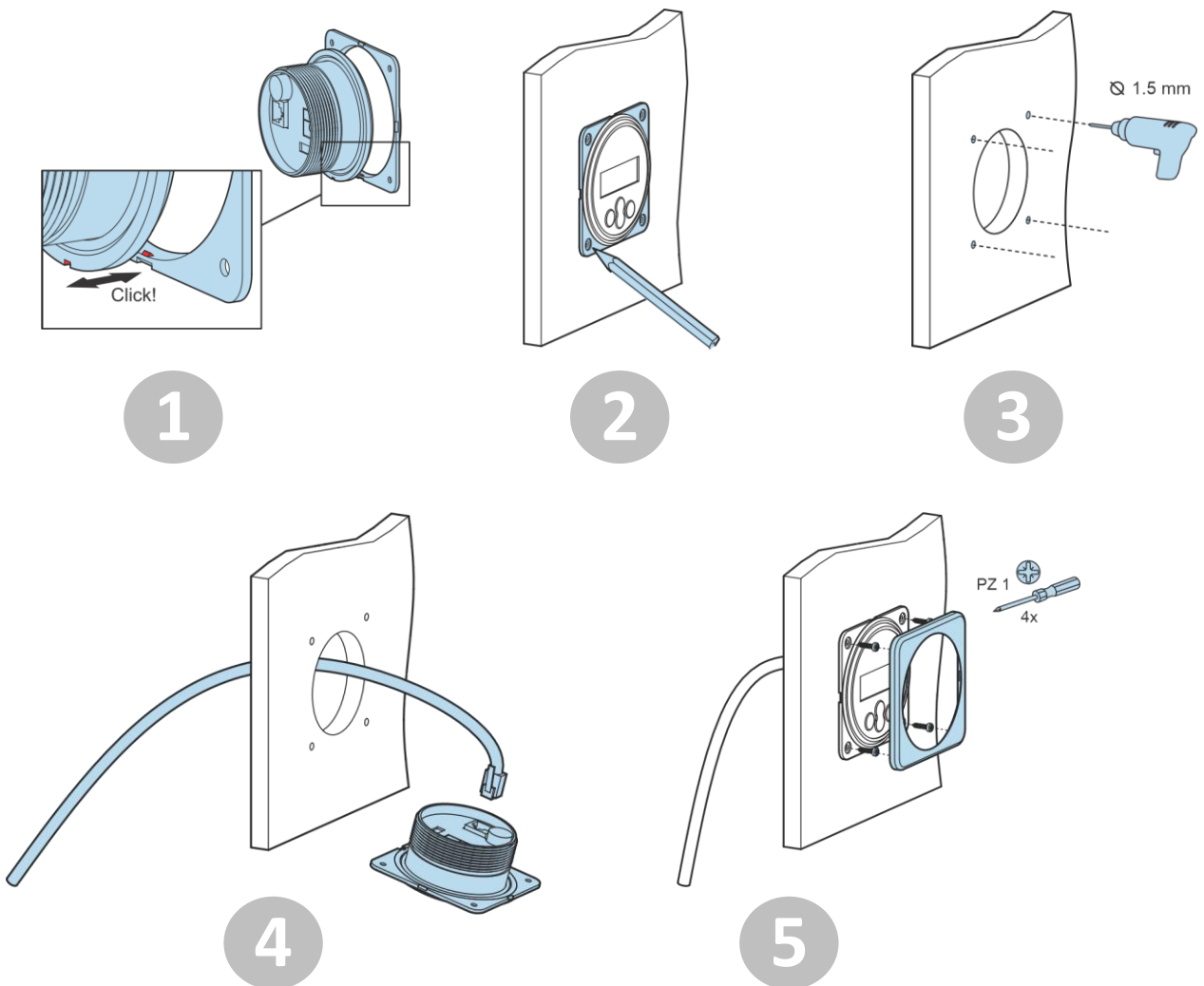

Option B

## 6

### BMV connections

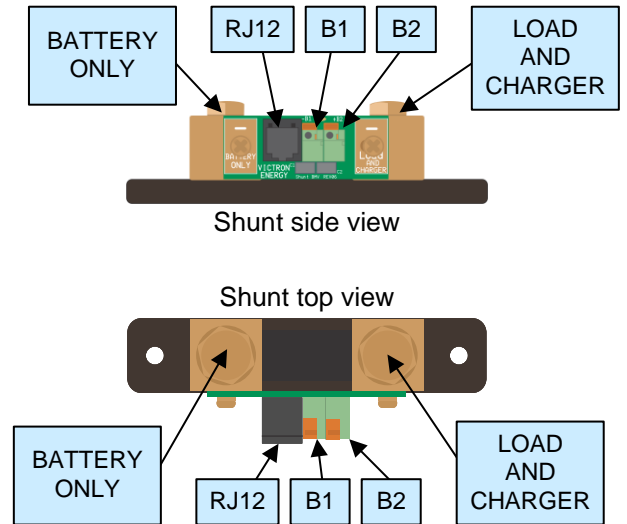
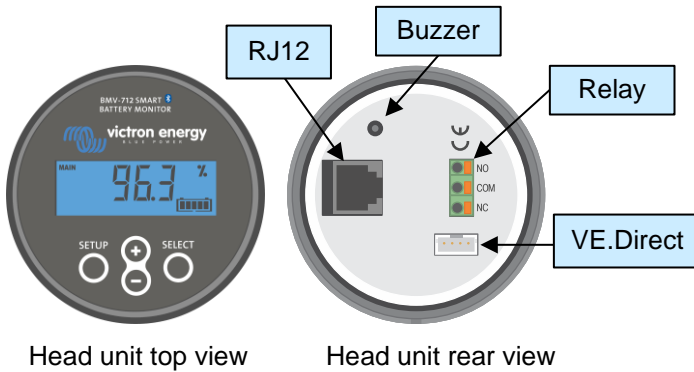

## 7

### Battery negative connection

- Connect the negative battery terminal to the BATTERY ONLY side of the shunt
- The shunt is the first and only thing that should be connected to the battery negative

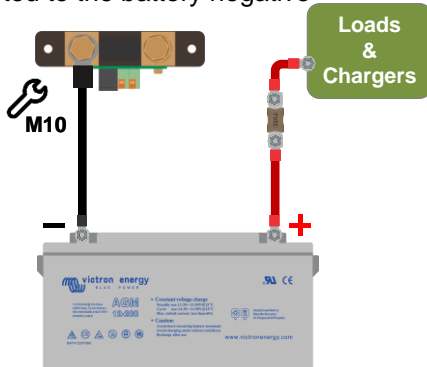

## 8

### System negative connection

- Connect the negative DC electrical system terminal to the LOAD AND CHARGER side of the shunt

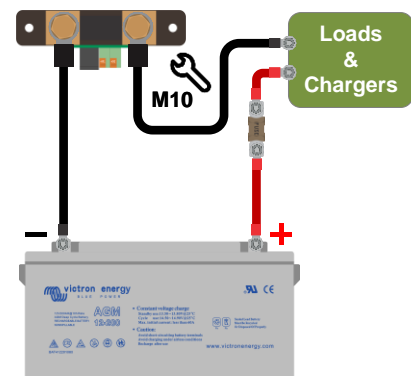

## 9

### Power cable connection

- Connect one of the power cables to the battery positive
- Push the other side into the B1 terminal on the shunt

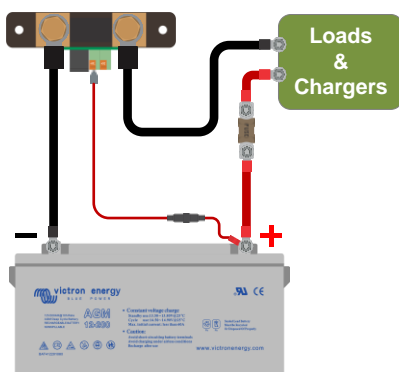

## 10

### Head unit connection

- Connect the RJ12 UTP cable between the shunt RJ12 terminal and the head unit RJ12 terminal

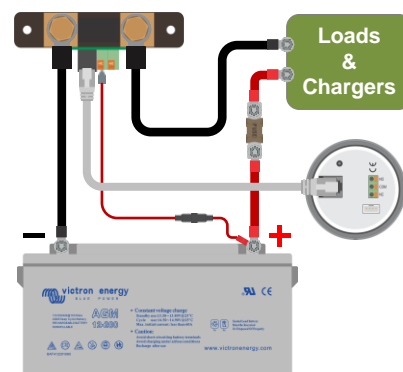

## 11

### Monitoring voltage of a second battery

- Connect the other power cable between the positive terminal of the second battery and the shunt B2 terminal
- Connect negative terminal of the second battery to the LOAD AND CHARGER side of the shunt

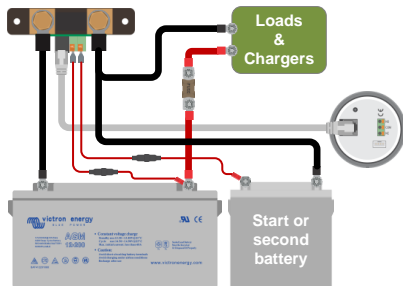

Optional

## 12

### Monitoring midpoint of a battery bank

- Connect the other power cable between the battery bank midpoint and the shunt B2 terminal
- For information on midpoint monitoring of battery banks consisting out of multiple batteries see the midpoint chapter in the BMV manual

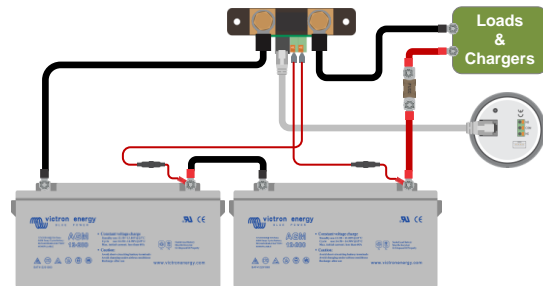

Optional

## 13

### Monitoring battery temperature

- The red power cables (included) are not used.
- Connect the (not included) temperature sensor ASS000100000 to the positive battery terminal.
- Connect the temperature sensor red wire to the B1 terminal and the black wire to the B2 terminal.

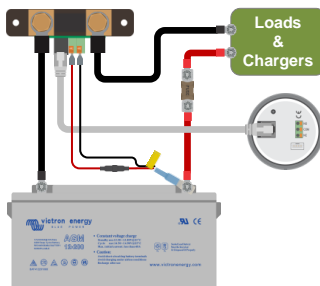

Optional

## 14

### Connecting to a GX monitoring device

- Connect the (not included) VE.Direct cable ASS03053xxxx between the VE.Direct terminal of the BMV and the GX device

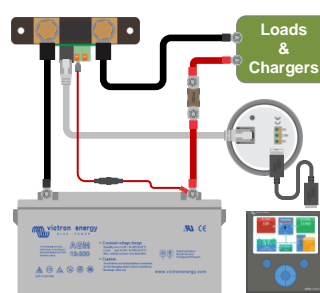

Victron GX product range



<https://ve3.nl/Venus-QS:start>

Optional

## 15

### Make essential settings

- **Set the battery capacity**
- Press any button
- Use + and – to enter value of first digit
- Press select to go to next digit
- Repeat until all 4 digits have been entered
- Press select to store setting, you will hear beep
- Press setup to next setting
- **Set the auxiliary input function (if used)**
- Press select
- Use + and – to choose start, temp or mid
- Press select
- **Additional settings apply for lithium batteries**
- See the manual

## 16

### VictronConnect

- For monitoring or changing settings
- Download the VictronConnect app
- Connect to the BMV via Bluetooth
- For more information on connecting via Bluetooth (or USB) see the VictronConnect manual

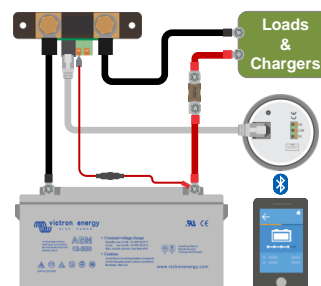

VictronConnect manual



<https://ve3.nl/VictronConnect-manual>